



ART. 9745-W13

Morsetto centrale per fissaggio moduli (pannelli) con cornice, Alluminio

Middle clamp for frame modules, Aluminum



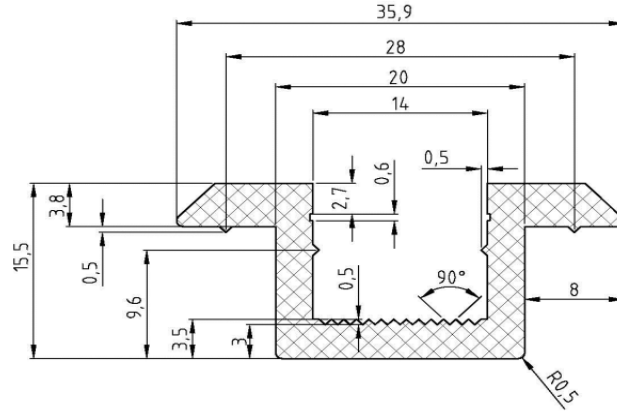

Codice Articolo <i>Item Number</i>	 Box	 Pallet
97453607013	100	10000



Lunghezza morsetti= 70 mm



End clamps Length= 70 mm

1

Viti per morsetti <i>Clamps screws</i>	Art. 5931 M 8 	Art. 5401-9490 Sfere Inox per viti 5931: <i>Balls for securing Allen screws SW6</i>	Asi 304 6,25/6,35 mm <i>Aisi 304 6,25/6,35 mm</i>
Rondelle di sicurezza <i>Locking washers</i>	Art. 1738 	rende le viti inviolabili <i>Balls for securing Allen screws SW6</i>	
Tassello scorrevole <i>Slot nut</i>	Art. 9431 		

Oppure /OR

2

Viti per morsetti <i>Clamps screws</i>	Art. 5931 M 8 	Art. 5401-9490 Sfere Inox per viti 5931: <i>Balls for securing Allen screws SW6</i>	Asi 304 6,25/6,35 mm <i>Aisi 304 6,25/6,35 mm</i>
Rondelle di sicurezza <i>Locking washers</i>	Non necessaria Not necessary	rende le viti inviolabili <i>Balls for securing Allen screws SW6</i>	
Dado quadro <i>Square nut</i>	Art. 0557 		

Altezza modulo (mm) <i>Module height (mm)</i>	con tassello scorrevole <i>with slot nut</i>	Rondella di sicurezza <i>Locking washer</i>	Con dado quadro <i>with square nut</i>
30	viti/ screw 8x35	X	viti/ screw 8x35 or 40
34	viti/ screw 8x35	Not necessary	viti/ screw 8x35 or 40
35	viti/ screw 8x40	X	viti/ screw 8x40 or 45
38	viti/ screw 8x40	Not necessary	viti/ screw 8x40 or 45
40	viti/ screw 8x45	X	viti/ screw 8x45 or 50
42	viti/ screw 8x45	Not necessary	viti/ screw 8x45 or 50
45	viti/ screw 8x50	X	viti/ screw 8x50 or 55
46	viti/ screw 8x50	X	viti/ screw 8x50 or 55
50	viti/ screw 8x55	X	viti/ screw 8x55 or 60



Esempi di fissaggio dei morsetti centrali:

posizionare il tassello scorrevole nel profilato superiore e spingerlo fino allo scatto. Avvitare nel tassello scorrevole il morsetto centrale con la relativa vite (a seconda dell'altezza del pannello fotovoltaico).

Attachment examples for middle clamps:

Swivel the Slot nut into the upper rail and click it in. Twist the middle clamp with the respective screw (depending on module height) into the Slot nut.